

System 8500

User's Manual



Document change log:

| Date: | Rev.: | Init: | Changes: |
|--------------|--------------|--------------|---|
| 23.11.2011 | 1.0 | TSS | This user's manual is intended for use with version 1.10 Firmware or higher |
| 01.05.2013 | 1.1 | PMPE | First completed revision. |
| 30.05.2013 | 1.2 | PMPE | Minor layout updates. |
| 22.08.2013 | 1.3 | PMPE | Correction of error in strap settings, table 12 |
| | | | |
| | | | |

Danfysik A/S

Gregersensvej 8 • DK-2630 Taastrup • Denmark

Tel. +45 7220 2400 • Fax +45 7220 2410 • sales@danfysik.dk • www.danfysik.com

VAT reg. No. DK 31 93 48 26 • Bankers: Jyske Bank, Denmark

Email sales: sales@danfysik.dk

Email service: service@danfysik.dk

IMPORTANT!

This documentation contains information which is the property of DANFYSIK A/S, Denmark.

It is submitted to you in confidence that it will not be disclosed or transmitted to others without DANFYSIK's authorization.

| | | |
|----------|---|-----------|
| 1 | INTRODUCTION..... | 5 |
| 1.1 | IMPORTANT SAFETY INFORMATION..... | 5 |
| 1.2 | GENERAL INTRODUCTION..... | 7 |
| 1.1.1. | <i>Intended use.....</i> | 7 |
| 1.3 | WARRANTY AND WARRANTY REPAIR..... | 7 |
| 2 | UNPACKING AND INSTALLATION..... | 9 |
| 2.1 | RECEIVING THE GOODS..... | 9 |
| 2.2 | INSTRUCTIONS FOR UNPACKING..... | 9 |
| 2.3 | INSTALLATION REQUIREMENTS..... | 10 |
| 2.4 | MECHANICAL INSTALLATION..... | 11 |
| 2.4.1 | <i>Transport to final position.....</i> | 11 |
| 2.4.2 | <i>Mechanical Dimensions.....</i> | 12 |
| 2.4.3 | <i>Water Installation.....</i> | 12 |
| 2.5 | ELECTRICAL INSTALLATION..... | 13 |
| 2.5.1 | <i>Connection of Main power.....</i> | 15 |
| 2.5.2 | <i>Connection of external control power (Optional).....</i> | 15 |
| 2.5.3 | <i>Connection of remote control cable (RS 232, RS 422 or RS 485).....</i> | 16 |
| 2.5.4 | <i>Connection of External Magnet Water flow switch (Optional).....</i> | 16 |
| 2.5.5 | <i>Connection of External Magnet Thermal breaker (Optional).....</i> | 16 |
| 2.5.6 | <i>Connection of External Emergency stop (Optional).....</i> | 17 |
| 2.5.7 | <i>Connection of Ethernet cable (Optional).....</i> | 17 |
| 2.5.8 | <i>Connection of IEEE cable (Optional).....</i> | 17 |
| 2.5.9 | <i>Connection of Analog setpoint (Optional).....</i> | 17 |
| 2.5.10 | <i>Connection of Analog fine adjustment (Optional).....</i> | 17 |
| 3 | OPERATING INSTRUCTIONS..... | 18 |
| 3.1 | FRONT PANEL CONTROLS..... | 18 |
| 3.2 | SWITCHING ON..... | 19 |
| 3.3 | OPERATING USING THE MANUAL CONTROL PANEL..... | 19 |
| 3.3.1 | <i>Main power ON / OFF and interlock RESET.....</i> | 19 |
| 3.3.2 | <i>The Display.....</i> | 20 |
| 3.3.3 | <i>Using the Manual Panel Menus.....</i> | 22 |
| 3.3.4 | <i>Control Menus.....</i> | 24 |
| 3.3.5 | <i>Output current setting.....</i> | 26 |
| 3.3.6 | <i>Polarity reversal (Optional).....</i> | 26 |
| 3.3.7 | <i>Local / Remote control.....</i> | 26 |
| 3.3.8 | <i>Interlock reading.....</i> | 27 |
| 3.3.9 | <i>A/D Channels.....</i> | 27 |
| 3.3.10 | <i>D/A Channels.....</i> | 27 |
| 3.3.11 | <i>SETUP of M-Panel.....</i> | 28 |
| 3.3.12 | <i>History window.....</i> | 28 |
| 3.3.13 | <i>Self-test.....</i> | 29 |
| 3.4 | OPERATING BY RS 232-C, RS422 OR RS 485 I/O..... | 31 |
| 3.4.1 | <i>Setting up the MPS.....</i> | 31 |
| 3.4.2 | <i>Resetting to factory defaults.....</i> | 31 |
| 3.4.3 | <i>Data communication.....</i> | 35 |
| 3.4.3.1 | <i>Termination using RS 422 or RS 485.....</i> | 37 |
| 3.4.4 | <i>Programming.....</i> | 37 |
| 3.4.5 | <i>Software Profile Programming (Optional).....</i> | 39 |
| 3.4.5.1 | <i>Arbitrary point ramp profile method.....</i> | 39 |
| 3.4.5.2 | <i>Equal time slot ramp profile method.....</i> | 40 |

| | |
|---|-----------|
| 3.4.5.3 Auto Slew Rate Ramp Profile method | 41 |
| 3.4.5.4 SW limits | 42 |
| 3.4.6 <i>Two level value set</i> | 42 |
| 3.4.6.1 Using the two level function | 43 |
| 3.5 INSTRUCTIONS FOR INITIAL REMOTE LINE SET UP RS232/RS422/RS485 | 45 |
| 3.6 OPERATING BY IEEE 488 (OPTIONAL) | 46 |
| 3.7 OPERATING BY ETHERNET INTERFACE (OPTIONAL) | 47 |
| 3.7.1 <i>Setting up the Ethernet interface</i> | 47 |
| 3.8 INSTRUCTIONS FOR USE OF ANALOG INPUT (OPTIONAL) | 48 |
| 3.9 INSTRUCTIONS FOR USE OF ANALOG FINE ADJUSTMENT (OPTIONAL) | 48 |
| 4 MAINTENANCE | 49 |
| 4.1 INTRODUCTION | 49 |
| 4.2 PREVENTIVE MAINTENANCE | 49 |
| 4.3 ADJUSTMENT AND CALIBRATION | 49 |
| 5 SPARE PARTS, ORDERING OF | 50 |
| 5.1 HANDLING ESD-SENSITIVE COMPONENTS | 50 |
| 6 TROUBLESHOOTING | 51 |

1 Introduction

1.1 Important safety information

This document may contain warnings:



GENERAL HAZARD

Indicates a potentially hazardous general situation. The keyword (DANGER, WARNING, and CAUTION) indicates the hazard level.



ELECTRICITY

Indicates a potentially hazardous electrical situation. The keyword (DANGER, WARNING, and CAUTION) indicates the hazard level.



MAGNETIC FIELD

Indicates a potentially hazardous magnetic field situation. The keyword (DANGER, WARNING, and CAUTION) indicates the hazard level.

1.1.1. General warnings

Please review the following safety precautions and all warning and caution information throughout the manual.



WARNING!

This Magnet Power Supply (MPS) is intended for professional incorporation into complete accelerator systems as a part of a fixed installation. If installed incorrectly it may present a safety hazard. Close attention is required to system design and electrical installation to avoid hazards in either normal operation or in the event of equipment malfunction.



WARNING!

Do not perform any flash test or voltage withstand test on the Magnet Power Supply. Any electrical measurements required must be carried out with power supply disconnected.



CAUTION!

Only qualified electricians are allowed to install and maintain this equipment.

**DANGER! ELECTRIC SHOCK HAZARD!**

Disconnect power at switch board before attempting to work on the Magnet Power Supply. High voltages are present at the terminals and within the power supply for up to 10 minutes after disconnection of the electrical supply. Always ensure by using a suitable measuring device that no voltage is present prior to commencing work.

**CAUTION!**

Ensure correct grounding connection. The grounding cable must be selected to be able to carry the maximum supply fault current. This is normally limited by fuses at the switch board. Fuses at the switch board must be selected according to local legislation or code.

1.2 General introduction

The System 8500 Precision Magnet Power Supplies are DC constant current output power supplies designed for applications requiring very high stability and low noise combined with reliability and ease of operation. The System 8500 is aimed at precision spectroscopy and ion beam transport applications. It is the result of an intensive development effort at Danfysik based on decades of experience in delivering precision DC Power Supplies to industrial and research laboratory users around the world.

The System 8500 is available as a range of power, control and interface modules which can be configured to meet specific application requirements with guaranteed performance.

- Current stability options of 0.1, 1 or 10 ppm classes.
- Output power from 5 kW to 1 MW.
- Output current (maximum) from 50 A to 10,000 A.
- ULTRASTAB Precision current transducer (DCCT = DC Current Transformer) to achieve new performance levels for stability and linearity over very wide current ranges.
- Optically isolated digital control to eliminate ground loops and conducted noise. The control and interface electronics modules are isolated from the power modules by an electrostatic and thermal shielding wall.

1.1.2. Intended use

The Magnet Power Supply (MPS) is intended for professional incorporation into complete accelerator systems as a part of a fixed installation. It must be installed in an enclosed operating area.

The intended use is to control a magnet by supplying the current for the magnet. The MPS includes an interlock system, which shuts down the power supply in case a number of predefined errors occur.

Only qualified personnel are allowed to install the MPS, and only instructed personnel are allowed to operate it.

In case of failure, the accelerator system must have the means to shut down in a safe manner.

1.3 Warranty and warranty repair

DANFYSIK A/S warrants that the products manufactured by us will be free from defects in material and workmanship that adversely would affect the normal functioning of the unit, for a period of 18 months from the date of shipment or 12 months from the date of installation whichever occurs first.

The exceptions to this are:

- a) Parts not manufactured by DANFYSIK A/S which are covered by the original equipment manufacturer's warranty.
- b) Repair work which is warranted for six (6) months from the date of shipment from the DANFYSIK works.

DANFYSIK A/S will repair or replace either on site or at the factory, at option and without charge, any equipment which proves to be defective within its warranty period.

In the case of warranty, DANFYSIK A/S will pay or reimburse lowest freight rate (two-way) of any item returned to DANFYSIK or our designated agent/representative, provided that prior written authorization for such return has been given by DANFYSIK A/S.

This warranty shall not apply to any equipment which has become defective or unworkable due to mishandling, improper maintenance, incorrect use, radiation damage or any other circumstance not generally acceptable for equipment of a similar type.

On standard products, DANFYSIK A/S reserves the right to make changes in design without incurring any obligation to modify previously manufactured units.

The foregoing is the full extent of this warranty, and no other warranty is expressed or implied. In no event shall DANFYSIK be liable for special damages arising from the delivery, late delivery or use of the equipment.

If any fault develops, the following steps should be taken:

- All RMA-cases are handled via Danfysik's web based RMA-system. It can be accessed from the official Danfysik web page www.danfysik.com (via the Service & Test tab), where a RMA Quick Guide also can be downloaded. Alternatively the RMA-system can be accessed directly via www.dfservice.dk/rma/
- Notify DANFYSIK A/S, giving full details of the problems, and include Model-Type and Serial number.

On receipt of this information, DANFYSIK A/S will give you either service information or instructions for shipping.

- All shipments of DANFYSIK equipment should be made according to our instructions and shipped in the original or a similar container.
- Only suitable materials are to be used for shipment.

2 Unpacking and installation

2.1 Receiving the goods

The Shipping container and the Magnet Power Supply should be thoroughly inspected for signs of obvious physical damage immediately upon receipt.

All materials in the container should be checked against the enclosed packing list. DANFYSIK A/S will not be responsible for shortages against the packing list unless notified immediately. The following must be included in the delivery:

- 1 pc of Magnet Power Supply
- User's Manual (this document)
- Main Schematic
- CD rom

Contents of the CD rom are:

- User's Manual
- Project specific addendum to the manual (if applicable)
- Main schematic
- Specifications sheet
- Scan of Quality Assurance documents – filled out test sheets and reports, obtained during production.
- Certificate of Conformance
- Programmer's Guide
- Technical note reg. MPS setup using DIP switches.

2.2 Instructions for unpacking

The Magnet Power Supply is shipped on a wooden pallet enclosed in either reinforced cardboard or wood crate.

Remove the packing straps and nails. If packed in a wood crate, the top lid should be removed first. If the equipment is damaged in any way, a claim should be filed with the shipping agent, and a full report of the damage should be forwarded to DANFYSIK A/S or our local agent/representative immediately.

Upon receipt of this report, you will be issued instructions for the repair, replacement or return shipment.

Please include the Model no, Type no, Serial no and Order no for the Magnet Power Supply on any communication with DANFYSIK A/S or our representatives.

2.3 Installation requirements

During installation of the Magnet Power Supply (MPS), local rules and regulations for electric power and water supplies should be respected and the following conditions and installations should be available.

- A normal, dust free room with humidity not above 80 % and a room temperature within 15 to 35 centigrade.
- Three-phase Mains voltage, switched and fused.
- Single-phase Control Power switched and fused. Normally this is supplied internally from the three-phase terminals. Optionally it may be supplied from an external power source. See the specifications sheet for the actual setting in this power supply
- Ground connection according to the local authority regulation and the requirements for the equipment.
- Cooling water supply which meets the following specifications:
 - Temperature within 15 to 35 centigrade.
 - Differential pressure: Min. 3 bar.
 - Max. inlet pressure: 12 bar.

See the specifications sheet for actual figures for this MPS.

Note:

For cooling of DANFYSIK power supplies and magnets, it is recommended to use demineralized water or pure water with an electrical conductivity of less than 10 μ S/cm. This reduces the electrolytic corrosion to a minimum.

Adding pure ethylene glycol to the cooling water with no other additives should not affect the electrolytic corrosion. However, it will reduce the thermal conductivity of the coolant. A percentage of 40% glycol reduces the conductivity by approx. 30%. It is recommended to use no more than 25% glycol corresponding to a reduction of thermal conductivity by approx. 17%. It may be necessary to increase the water flow in the MPS.

No other additives should be used.

During operation, the conductivity of the coolant should be checked regularly. A few days of operation with water of poor quality can cause more corrosion damage than several years of operation with good quality water.

2.4 Mechanical Installation

2.4.1 Transport to final position

- Preferably, the Magnet Power Supply (MPS) should be transported to the final position by attaching the four top lugs to a winch or a crane.
- If this is not possible, transport the MPS to its final position by using a pallet jack as shown below. To prevent damage and/or scratches and dents to the MPS, when lifting it, a protruding piece of wood (or equivalent) can be placed on the forks of the pallet jack, thereby preventing direct contact between the cabinet and the forks.

Note: This does not apply to units fitted with castor wheels.



CAUTION!

Caution is to be taken, when transporting the MPS. The unit weighs several hundred kilograms. Transport with care.

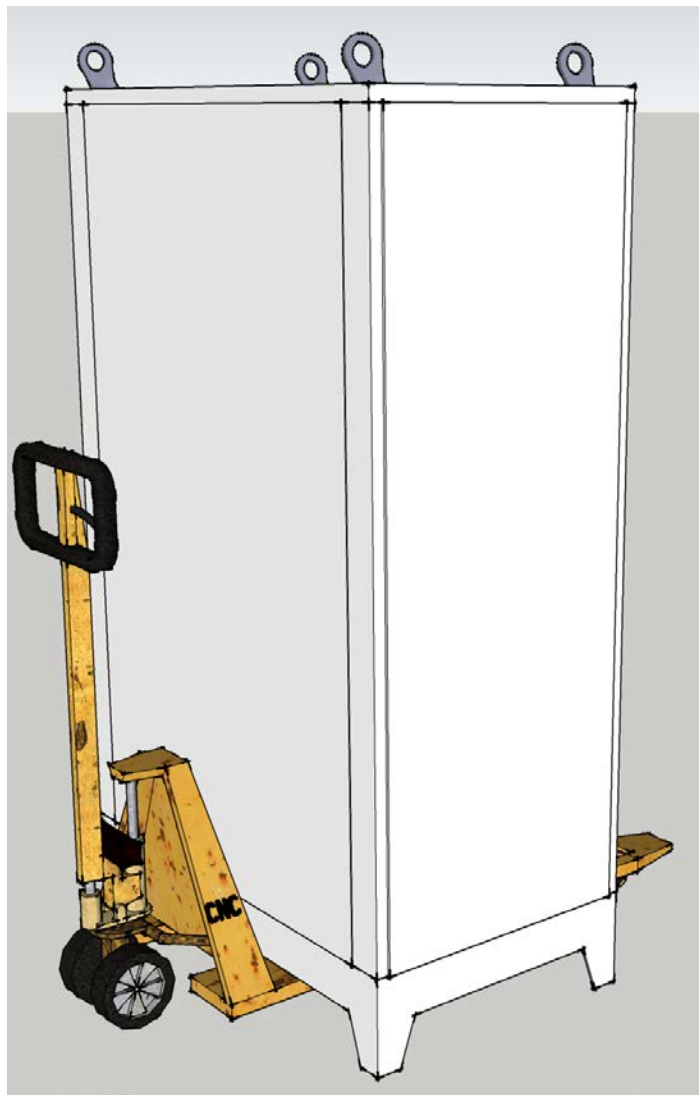

2.4.2 Mechanical Dimensions

- Space constraints depend on the cabinet type. See the table below for possible footprints. The cabinets are either 1400 or 1800 mm high.

Table 1. Cabinet footprints

| | | | |
|------------|---------|------|------|
| Width [mm] | 612 x N | - | - |
| Depth [mm] | 800 | 1050 | 1200 |

Where 'N' represents the number of cabinets used to build the Magnet Power Supply.

See the specifications sheet for the actual figures for this Magnet Power Supply.

2.4.3 Water Installation

- The connection for the cooling water supply is normally located in the bottom rear of the cabinet. **Note:** The location may differ from default upon customer request.
- See the specifications sheet for size of fittings.
- A pressurized test should be done for a duration of 15 minutes with 12 bars of pressure.

2.5 Electrical Installation

Please refer to the main schematic for the overall electrical connections in this Magnet Power Supply. The figures below and on the following page shows all peripheral connections¹ incl. options.

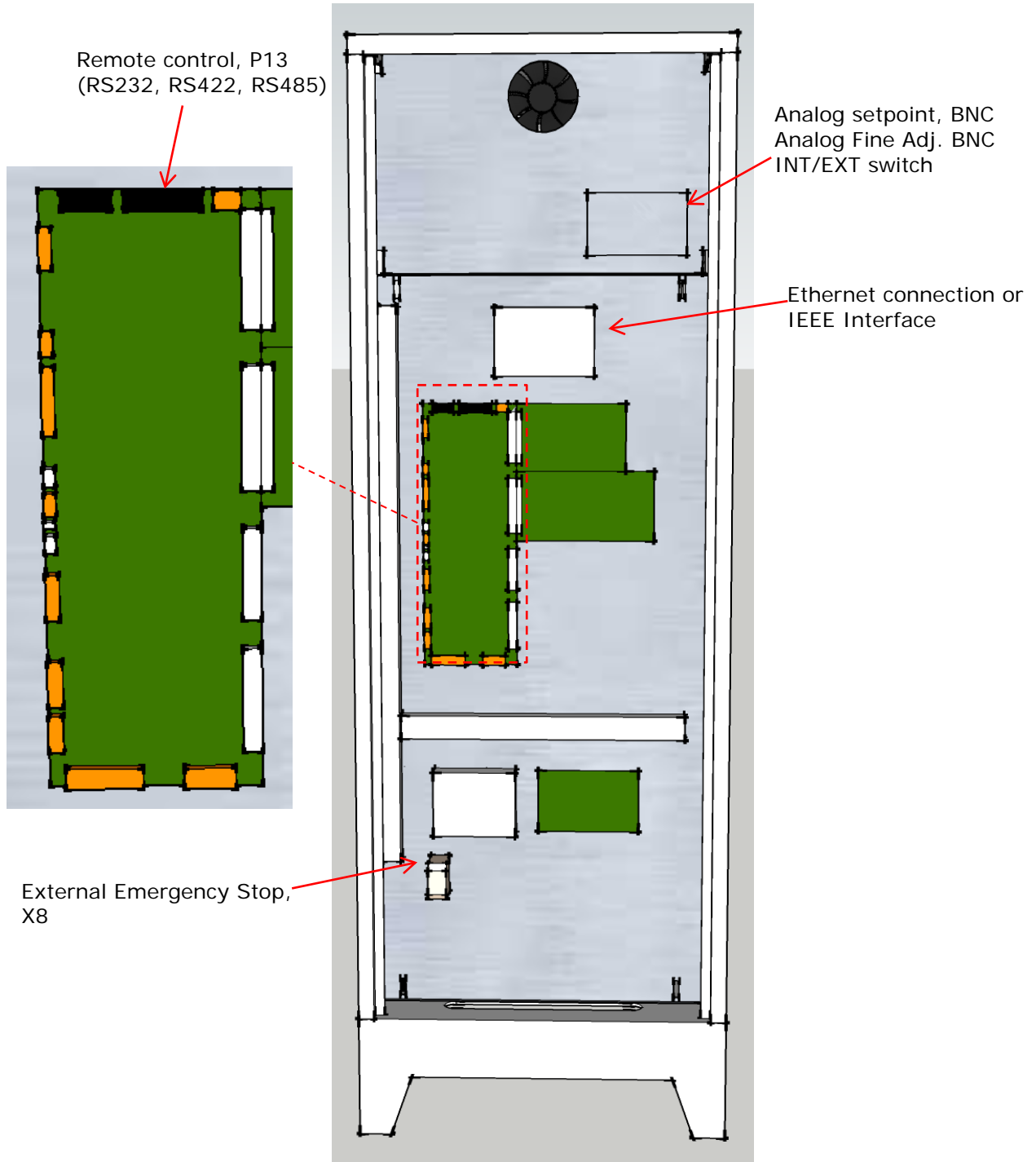

Figure 1. Electrical connections, cabinet front

¹ Physical placement may differ from default on customer request.

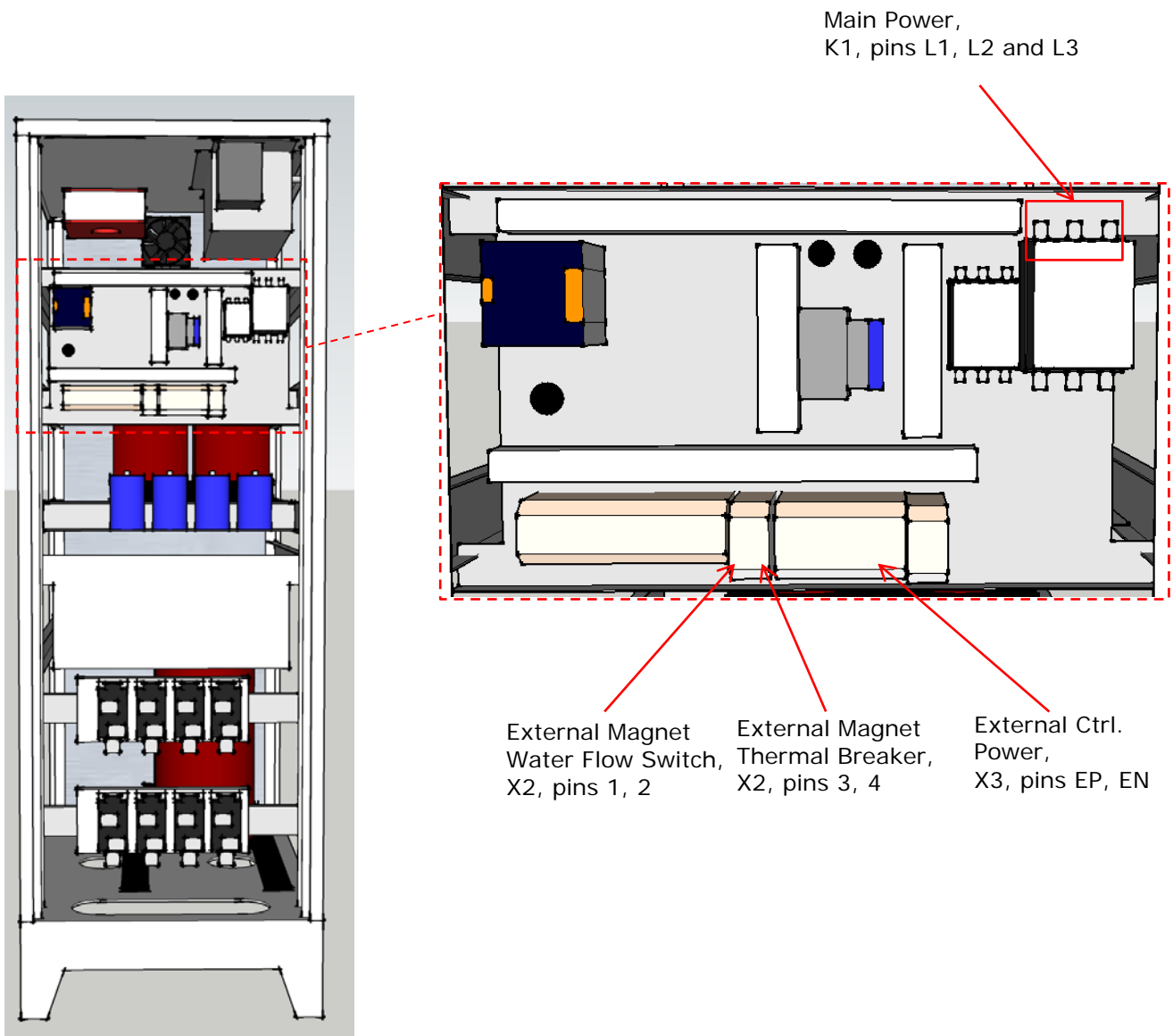

Figure 2. Electrical connections, cabinet rear

2.5.1 Connection of Main power

- Check that the main voltage and frequency matches to the specified and labeled requirements.
- The connection for Main power is located on the contactor plate behind the back door. See Figure 2 above. Note! Connection may differ from default, if the MPS is equipped with an EMI-filter. Please refer to the main schematic.
- Connect the main power cables to contactor K1, pins L1, L2 and L3
- Power terminal torque settings must conform to the table below.

| | | | | | |
|-------------------------------|-----|-----|-----|-----|------|
| Thread size [mm] | 4.0 | 5.0 | 6.0 | 8.0 | 10.0 |
| Tightening torque [Nm] | 1.2 | 2.0 | 3.0 | 6.0 | 10.0 |

Table 2. Tightening torque, Power terminals (DS/EN 61010-1:2010)

2.5.2 Connection of external control power (Optional)

- Check that the control voltage and frequency matches to the specified and labeled requirements.
- The connection for external control power is located on the contactor plate behind the back door. See Figure 2 above.
- Connect the power cables to X3, pins EP and EN (External P and N, respectively).

2.5.3 Connection of remote control cable (RS 232, RS 422 or RS 485)

- The connection for the remote control cable (denoted X7 on main schematic) is located on the control board behind the front door.
- Connect the cable to connector P13 on the control board. See Figure 1 above.
- In normal operation, the cable can be guided into the cabinet via the front hole in the bottom of the cabinet.
- See the tables below for pin outs.

Table 3. RS 232C Pin out DB25

| Pin No. | Signal |
|---------|--------|
| 2 | Tx |
| 3 | Rx |
| 7 | GND |

Table 4. RS 422 Pin out DB25

| Pin No. | Signal |
|---------|---------|
| 7 | GND |
| 9 | Tx High |
| 10 | Tx Low |
| 11 | Rx High |
| 12 | Rx Low |

Table 5. RS 485 Pin out DB25

| Pin No. | Signal |
|---------|--------------|
| 7 | GND |
| 9 | Tx / Rx High |
| 10 | Tx / Rx Low |

See chapter 3.4.3 – Data communication for additional information.

Instructions for initial remote line setup are given in chapter 3.5.

2.5.4 Connection of External Magnet Water flow switch (Optional)

- The connection for the water flow switch (denoted X2 on main schematic) is located on the contactor plate behind the back door. See Figure 2 above.
- If the magnet is provided with a water-flow switch, connect the contacts to X2, pins 1 and 2.
- If no external flow switch is used, the terminals are short-circuited during factory test.

2.5.5 Connection of External Magnet Thermal breaker (Optional)

- The connection for the thermal breaker (denoted X2 on main schematic) is located on the contactor plate behind the back door. See Figure 2 above.
- If the magnet is provided with a thermal breaker, connect the contacts to X2, pins 3 and 4.
- If no external thermal breaker is used, the terminals are short-circuited during factory test.

2.5.6 Connection of External Emergency stop (Optional)

- An external emergency switch can be connected to X8 pin 5-6 (Line) and pin 7-8 (Interlock). X8 is located on the electronic plate behind the front door. See Figure 1 above.
- The emergency switch is in series with the control power (AC) to the main circuit breaker coil. If the circuit is open, the main circuit breaker is switched off. The emergency switch must have two sets of normally closed (N/C) contacts. Connect one to pin 5 and 6 and the other to pin 7 and 8. By connecting to pin 7 and 8, an interlock is set when the emergency switch is open.
- If no external emergency switch is used, the terminals are short-circuited during factory test.

2.5.7 Connection of Ethernet cable (Optional)

- The connection for the Ethernet cable (denoted X7 on main schematic) is located on the electronic plate behind the front door. See Figure 1 above.

2.5.8 Connection of IEEE cable (Optional)

- The connection for the IEEE cable (denoted X7 on main schematic) is located on the electronic plate behind the front door. See Figure 1 above.

2.5.9 Connection of Analog setpoint (Optional)

- The connection for the analog setpoint is located on the electronic plate behind the front door. See Figure 1 above.
- Pin out: BNC plug with isolated ground.

2.5.10 Connection of Analog fine adjustment (Optional)

- The connection for the fine adjustment is located on the electronic plate behind the front door. See Figure 1 above.
- Pin out: BNC plug with isolated ground.

3 Operating instructions

This chapter outlines the procedure for the operation in local and remote control mode.

It identifies and describes the controls and indicators on the Operator Control Panel (M-Panel Graphical).

Instructions for initial remote line set up are given in chapter 3.5.

3.1 Front panel controls

1. Graphic display 240*64
2. Main power is "ON" LED.
3. Main power "ON" push button.
4. Main power is "OFF" LED.
5. Main power "OFF" push button.
6. READY LED indicates when the actual output current is within a predefined limit.
7. Control Power "ON". Back light is lit.
8. Interlock "RESET" push button.
9. Sum Interlock LED.
10. MENU - Enter / Exit pull down menus.
11. Navigation keys. ▲ ▼ ◀ ▶
12. ENTER ↵ - Enter / Exit parameter change

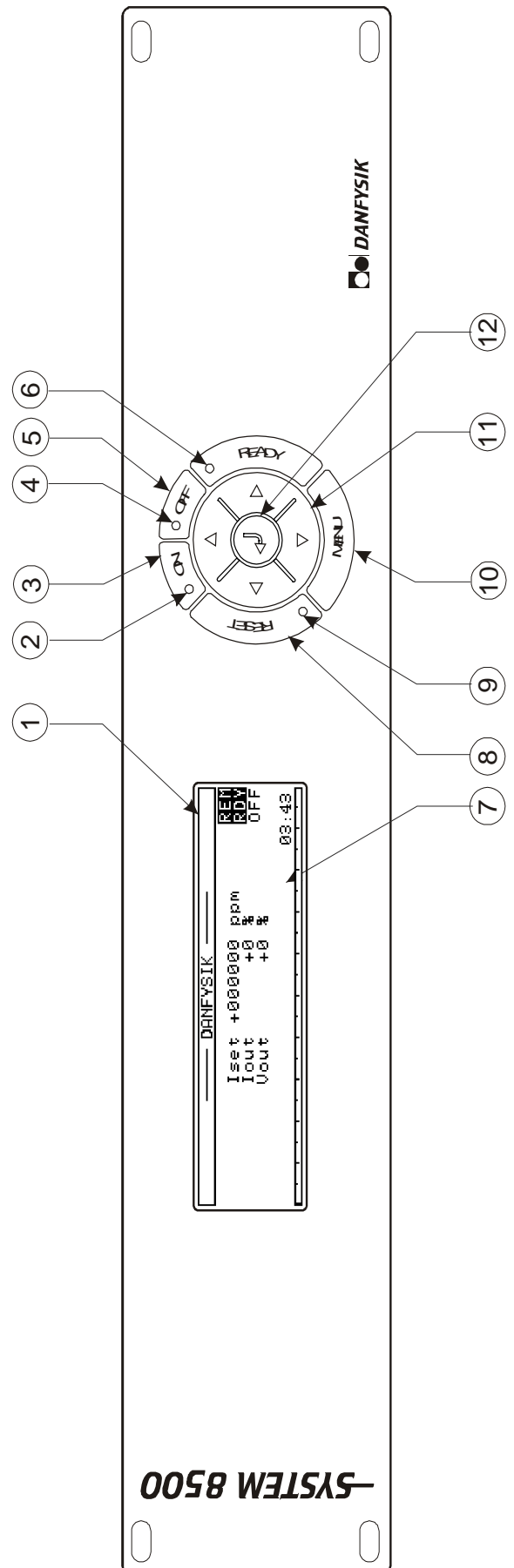

3.2 Switching on

After the Magnet Power Supply (MPS) has been connected to the line voltages and water cooling, in accordance with chapter 1.3 and 2, it can be switched ON.

Immediately after the MPS is switched ON, the M-Panel displays a start-up screen, which control module it is connected to and if an alternative text table has been downloaded, while the local line is checked. All LEDs on the Control Board light up for approximately 3 sec. After approximately 5sec., the panel is ready for use. The remote line is ready for use after approximately 3 sec.

Make sure that the time between switching the control power OFF and ON again is at least 5 sec. to ensure a correct cold start (initialization of the Power Supply).

By use of the front panel controls (see chapter 3.1) carry out the following points:

1. Select LOCAL CONTROL mode. (Changed in the CMD-menu. "LOC" text appears in the display) (1). When turning the power supply ON for the first time, it is recommended to do it in the LOCAL CONTROL mode.
2. If any interlocks are set, push the "Reset" button (8). Remove the faults if the interlocks are not reset.
3. Set the desired output current by use of the SET-menu.
4. Switch the Main power "ON" (3).
5. The READY LED (6) turns on, when the output current is equal to the pre-set value within a given accuracy, typically ± 200 ppm.
6. Switch the main power "OFF" (5).

3.3 Operating using the Manual Control Panel

The MANUAL CONTROL PANEL (M-Panel Graphical) is an interface module to the SYSTEM 8500 Magnet Power Supply (MPS).

The Control Panel can be connected and disconnected from the MPS without affecting the operation. Communication between the MPS and the Operator Control Panel is by a serial link, and may be physically located at the MPS or up to 400 meters away from it.

Control from the Operator Control Panel requires that LOCAL control mode is asserted; otherwise only status and parameters can be read.

3.3.1 Main power ON / OFF and interlock RESET

The basic function is to turn the Magnet Power Supply (MPS) ON / OFF and to RESET pending interlocks. All controlled from a single button. See chapter 3.1 for further information on the button location. Setting the output current is done through one of the pull down menus described in chapters 3.3.3 and 3.3.4.

When the MPS is ON, the LED in the ON button area will light up.

When the MPS is OFF, the LED in the OFF button area will light up.

If an interlock is present, the LED inside the RESET button will light up. Pressing the RESET button will clear the interlocks that are not present anymore.

If an interlock is present, it will also be represented on the display at the lower right corner.

3.3.2 The Display

The display is a multi-purpose graphic window. The window can be divided into the following groups:

Default window:

The default window is shown in Figure 3. If the M-Panel is unused for 5 minutes, the M-Panel will automatically enter this state for safety reasons. Escaping from any menu back to this default window can be performed by pressing the "MENU" button again. Note that any on-going operation will be cancelled.

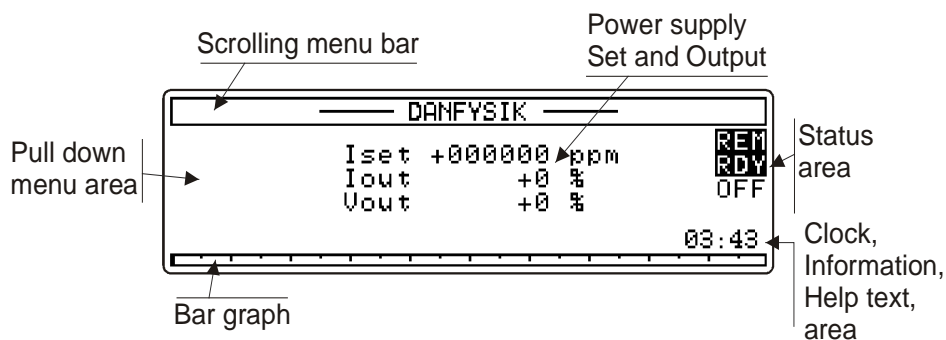

Figure 3. Default window

Scrolling menu bar:

The upper part of the display is normally used for displaying the available top menus. In the default window, "----- DANFYSIK -----" will be displayed. It is called "scrolling menu bar" because contrary to normal Windows © pull down menus, it is the top menu that scrolls with the "◀" "▶" buttons.

Pull down menu area:

The pull-down menus are always shown in this area. If a pull down menu has sub menus, they will advance to the right. The second submenu will overwrite the "Set and Output" area. Power supply Set and Output Upper line displays the output current setting with six digits. After a cold start it displays "SET 000000 ppm". When full output current is set, it displays "Iset 999999 ppm", which is to be read as 99.9999 % of full scale. If required a setting in Ampere with six digits and a decimal point can be adapted. This will be set at Danfysik during test or by Danfysik service personnel.

The middle line displays the actual output current with two digits. E.g. "Iout 54 %" means that the current is 54 % of full scale. This reading is made by the internal 8 Bit bipolar ADC. If a more accurate read out is required, the Control module can be added with a 16 Bit ADC. The current will then be automatically displayed by six digits where the last digit always will be zero. That is with five significant digits. E.g. "Iout 346340 ppm" means that the current is 34.634 % of full scale. If required, an output reading in Ampere with two or five digits can be adapted. This will be set at Danfysik during test or by Danfysik service personnel.

The lower line displays the actual output voltage with two digits. E.g. "Vout 45 %" means that the voltage is 45 % of full scale. This reading is made by the internal 8 Bit bipolar ADC. If required, an output reading in Volts with two digits can be adapted. This will be set at Danfysik during test or by Danfysik service personnel.

Pop Up Window:

A pop-up window displaying numerous interlocks is shown in Figure 6. The bar at the bottom of the pop-up indicates that there is no further information downwards, and the arrow at the top indicates that pressing the "▲" button will display the above listed interlocks. If a pop-up window contains values to be set, the line to be changed will be displayed inversed (cursor over the line). Use the "◀" "▶" buttons to change the value. "▲" & "▼" scrolls between the lines.

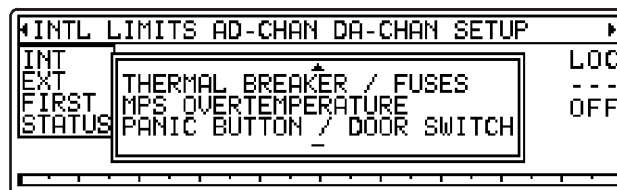

Figure 6. Pop up Window

History Window:

The history window can be seen as an oscilloscope screen with auto scaling. Figure 7 shows an example history window set to absolute scale with visible scale units. The Δ indicates one pixel unit. See chapter 3.3.12 for a detailed description of this function.



Figure 7. History Window

3.3.3 Using the Manual Panel Menus

This chapter shortly describes the use of the M-Panel Graphical. See chapter 3.3.4 for a detailed description of the different menus.

The user interface of the M-Panel Graphical is based upon pull down menus. To display the menus, simply press the MENU button.

To prevent unnecessary hiding of the main display (set current, output current and voltage) the pull down menus are always displayed left aligned.

Notes:

- If no menus have been used within 5 minutes, the display automatically switches back to the default window aborting any current operation.
- Changing the command status to REMote from a *remote* location automatically aborts any current *local* operation.

The menu navigation is as follows:

- With the menu bar visible (i.e. the MENU button pressed once), pressing the "◀" or "▶" buttons will scroll through the horizontal menu groups. The "▲" and "▼" buttons scrolls through the pull down menus in the selected group.
- If the selected menu contains a submenu, the "▶" button will access it.

- When the desired menu is found, it is entered by pressing the "↵" Enter key.
 - If the chosen menu has a parameter to be edited (e.g. the "set current" menu), a window with the parameter will be shown.
 - Move the cursor to the desired position with the "◀" and "▶" buttons. The parameter is edited with the "▲" and "▼" buttons. Holding either the "▲" or "▼" key pressed when editing a digit will initiate an auto increment/decrement function. Pressing the "↵" Enter key ends the editing.
 - Pressing the MENU button while editing a parameter will abort/escape the current operation.
 - If the chosen menu only contains status data (e.g. the "interlock" menu), a pop-up window with the status data will be shown.
 - If the menu is a command (e.g. the LOCAL or REMOTE setting in the CMD menu), the command will be executed immediately. The cursor will stay at its position.
- The pop-up windows are exited by pressing the "↵" Enter key once again.
- The menu bar is exited (i.e. back to default screen) by pressing the MENU button once again.

Hints and shortcuts:

- To ease daily use, the "↵" Enter key may be used instead of the "▼" or "▶" key in some situations:
 - E.g. when scrolling from the top of a pull down menu to the next menu item, the "↵" Enter key will do the same as the "▼" key.
 - E.g. when standing in a menu containing a submenu, the "↵" Enter key will do the same as the "▶" key.
- When pressing the MENU key from the default window, the first accessible menu will be either the SET (Set output current) or the INTL (Interlocks) menu. The latter if one or more interlocks are present. This minimizes the number of keys to be pressed when setting the output current or viewing any active interlocks to "MENU", "▼", "↵".

3.3.4 Control Menus

| Scroll menu | Sub menu 1 | Sub menu 2 | Sub menu 3 | Comment | |
|--|-----------------------------|---|--------------------|---|-------------------------|
| SET | | | | Setting of output current | |
| | CURRENT | | | Set output current immediately | |
| | CURRENT d _{elayed} | | | Set output current after "↓" | |
| | MEM | | | | Memory function |
| | | RCL | Reg 0 →9 | | Recalls one memory |
| | | STO | Reg 0 →9 | | Stores to a memory |
| | MAX/MIN | | | | Set current to one end. |
| | | 0% | | | Set current to zero |
| 100% | | | Set current to max | | |
| CMD | | | | Control Command line | |
| | REM | | | Set to Remote Control | |
| | LOC | | | Set to Local control | |
| | ADR | | | Select a multidrop address | |
| INTL | | | | Display Interlocks / Status | |
| | INT | | | Internal Interlocks | |
| | | SPARE INTERLOCK DC OVERCURRENT (OCP) DC OVERLOAD REGULATION MODULE FAILURE PREREGULATOR FAILURE PHASE FAILURE MPS WATERFLOW FAILURE EARTH LEAKAGE FAILURE THERMAL BREAKER / FUSES MPS OVERTEMPERATURE PANIC BUTTON / DOOR SWITCH DC OVERLOAD | | May differ dependent on customer request. | |
| | EXT | | | External interlocks | |
| | | MAGNET WATER FLOW FAILURE MAGNET OVER TEMPERATURE | | | |
| | FIRST | Same list as for INT | | First occurred Interlock | |
| | STATUS | | | Status bits | |
| REGULATION TR. <>0", ONE TRANSISTOR FAULT BATTERY LOW STATUS OF TP9=0 POLARITY SW. INHIBIT TP8=0 | | May differ dependent on customer request. | | | |
| POL | | | | Change output polarity | |
| | POS + | | | Set polarity to + | |
| | NEG - | | | Set polarity to - | |
| | +<>- | | | Invert output polarity | |
| LIMITS | | | | Value limitations | |
| | I SET | | | Current value limitations | |
| | | POS | | Positive limit | |
| | | NEG | | Negative limit | |

| Scroll menu | Sub menu 1 | Sub menu 2 | Sub menu 3 | Comment |
|-------------|------------|--|------------|---|
| AD-CHAN | | | | |
| | CHN 0-8 | | | A/D Channels 0 to 8 |
| | | Iout 8 bit resolution Magnet Field Vout Internal +15V Internal -15V Internal +5V Delta Temp Passbank drop Iout 16 bit resolution | | Output Current 0-120% Optional Hall-probe required. Output Voltage 0 - 120% Internal control voltage Internal control voltage Internal control voltage DAC deviation temperature $\pm 7.5^{\circ}\text{C}$ Transistor bank voltage drop 0-120V Output current 5 significant digits |
| | CHN 9-15 | | | A/D Channels 9 to 15 |
| | | Iout bar graph 1 Iout bar graph 2 Iout optional Vout optional Water flow Free from plug P29 Free from plug P19 | | Internal use Internal use From CAMAC line From CAMAC line Rotary sensor required |
| DA-CHAN | | | | Setting of D/A Channels |
| | Slew-Rate | | | Set slew rate |
| SETUP | | | | Sets working conditions |
| | BAUD | | | M-Panel Baud rate setting |
| | | 1200, - 38400 2400, - 57600 9600, - 76800 19200, - 115200 | | Communication may be lost when changing the baud rate. |
| | COLOUR | | | LED Colour |
| | | Interlock PSU ready Power ON Power OFF | | Set to RED, GREEN or "YELLOW" |
| | SOUND | | | Buzzer ON or OFF |
| | DEFAULT | | | Set to factory default |
| | OPTION | | | |
| | | ADR | | Multidrop Address enable |
| | | SLEW-R | | Slew Rate setting enable |
| HISTORY | | | | |
| | OPEN LOG | | | Se chapter 3.3.12 for further information. |

3.3.5 Output current setting

The output current may be set immediately as a potentiometer "SET CURRENT" or first pre-set "SET CURRENTd" and thereafter accepted with the "↵" button. Set the output current by choosing the "SET CURRENT" menu, position the cursor above the digit to alter and adjust the digit with the "▲" or "▼" button.

When the output current is within a predefined limit of the set value, the "READY" LED will turn ON.

It is also possible to set the output current to a predefined value, either using the storage registers (STO, RCL in the MEM menu), to maximum current (=100%) or to zero (=0%).

The maximum allowed set value can be limited through the LIMITS menu. Separate limits can be set for the positive and the negative set values. Therefore, if it is not possible to adjust the current above a certain value, then check the limits.

Note:

The storage and limit registers are saved within the M-Panel and can therefore not be used in remote control. In a multidrop environment e.g. all power supplies will share the same limit.

3.3.6 Polarity reversal (Optional)

If a polarity reversal switch is installed, a sign will be shown in front of the set value. (+ or -).

A polarity reversal procedure can be initiated either through the "POL" menu or simply by putting the cursor above the sign in the "SET CURRENT" menu and changing the sign with either the "▲" or "▼" button.

For bipolar power supplies the set value will just change its sign, but for unipolar supplies equipped with a polarity reversal motor driven switch the following sequence is initiated:

1. The DAC is set to zero.
2. When the current is zero, the Main Power is switched OFF.
3. The switch motor is activated to reverse the polarity.
4. When the switch is in correct position, the DAC will be set back to the original value and the Main Power will be switched ON again.
5. The output current will increase until it reaches the same or the new value again.

Note: If the Main Power is OFF the above sequence is initiated but the Main Power is not switched ON.

3.3.7 Local / Remote control

When the Magnet Power Supply (MPS) is in LOCAL control, "LOC" is shown on the right side of the display. In REMote control "REM" is shown inversed on the right side of the display.

If LOCAL CONTROL has been required by the Control Panel, the MPS is locked in Local Control mode, and Remote Control cannot be requested by the remote line. If LOCAL CONTROL has been initiated the Remote Line, the MPS is not locked in Local Control.

The control mode can be changed from the CMD menu.

In REMOTE CONTROL mode all local commands are ignored, and "ILLEGAL COMMAND" is displayed. All status information will still be displayed.

3.3.8 Interlock reading

Status and Interlocks messages are found under the INTL menu. For a better overview the messages are divided into four categories:

- Internal Interlocks (INT). Interlocks generated from faults inside the cabinet.
- External Interlocks (EXT). Interlocks generated from faults outside the cabinet.
- FIRST. First occurred interlock. In case of several interlocks occurring promptly after each other, the first one will be caught with the time of occurrence (In case the time is not set right, the present time is shown too. It is then possible to calculate the exact time of occurrence).
- STATUS. All status messages.

For further information see the menu tables, chapter 3.3.4.

Interlock labels may be renamed. This is performed at Danfysik during factory test or by Danfysik service personnel.

3.3.9 A/D Channels

Together with the output current and voltage many other analogue values are monitored. These can be seen under the AD-CHAN menu. Please refer to the menu tables, chapter 3.3.4 and the AD software command in the programmers guide for further information.

Analogue channel names and units may be renamed and re-scaled. This is performed at Danfysik during factory test or by Danfysik service personnel.

3.3.10 D/A Channels

Extra values to be set are performed under the DA-CHAN menu. At the moment only the slew rate value is implemented. This menu sets a hardware controlled slew rate value if enabled and the Magnet Power Supply is equipped with this feature (Enabled through the SETUP menu).

When equipped with the slew rate function, the interpretation of the slew rate value may vary from supply to supply, depending on the DAC Module installed.

The table below shows the resolution of the different DAC Modules available. Please refer to the main schematic to see, which DAC Module is installed in this Magnet Power Supply.

Table 6. DAC resolution

| DAC Module P/N | Description | Resolution [bits] |
|----------------|------------------|-------------------|
| 8100082322 | MPS 854 Std. DAC | 18 |
| 8100084201 | MPS 855 Std. DAC | 16 |
| 8100091604 | I-loop DAC | 20 |
| 8100092066 | MPS 853 Std. DAC | 18 |

3.3.11 SETUP of M-Panel

The working condition of the M-Panel is set through the SETUP menu. Normally all settings are pre-set during factory test and should *not* be altered. In case of a spare part replacement changes to the default settings may be required.

Five submenus are available:

- BAUD. Set the M-Panel communication speed. (Normally 9600 baud)
- COLOUR. LED colour. RED, GREEN or "Yellow"
- SOUND. Enable or disable the artificial click sound when a button is pressed.
- DEFAULT. Restore all settings to default settings.
- OPTION. Enable or disable the slew rate setting and the multidrop address facility.

Note: Interlock labels and AD/DA channel scales, units and names might also be changed. If so, this will be shown on the upstart screen as a pop up window with the text "*Using download text table*". In any other case the text "*Using default text table*" will be shown. Text and scale conversions are performed at Danfysik during factory test or by Danfysik service personnel.

3.3.12 History window

The history window can be seen as an oscilloscope picture of the output current. The data is taken from the internal 8 or 16 bit ADC.

Note: As the ADCs are only used for monitoring, are not temperature compensated and have lower resolution, the recorded traces **cannot** be used as an indication of the stability.

The picture (output current trace) can be shown in two modes: absolute and dynamic scale. In absolute scale the window will always have 0% at the bottom (-100% for bipolar supplies) and 100% at the top. The dynamic scale is automatically scaled for best pixel resolution. One pixel equals the ADC resolution or less to display the total trace current variation. The scale text indicates the actual chosen resolution for the current and the time.

Output current values are sampled every second and stored in a log-buffer. The log-buffer content is displayed via a viewport. The oldest samples are to the left and the newest samples are to the right. The view on the log-buffer can be moved backward or forward in time with the left-right arrows.

The size of the viewport can be increased or decreased with the up-down arrows to show more or less log-buffer samples at a time:

- The maximum is 30 log-buffer samples per pixel, which equals 1 minute per pixel and a total view of 2 hours.
- The minimum is 1 log-buffer sample per pixel, which equals 1 second per pixel and a total view of 4 minutes.

If the sample values differ within a time frame represented by one pixel column, then the sample values are displayed as a vertical pixel bar.

In tracking mode the viewport is automatically moved to the left, when new samples are added to the log buffer, so the newest sample always becomes visible. When the log buffer is full the oldest sample is skipped, when new samples are added to the buffer.

The log-buffer sample at the right edge of the viewport is used as anchor when the viewport size is changed with the up/down arrows. When tracking mode is enabled, this corresponds to the use of present time as an anchor.

Pressing the MENU button inside the History window will not escape the operation, but will reveal a pop up option window. This is shown in Figure 8.

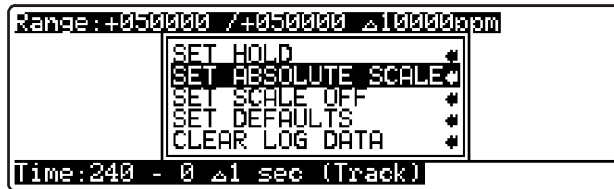

Figure 8. Pop up options in History Window

History window submenus:

- SET HOLD/TRACKING. Stop or enable sampling. Used for e.g. zooming in on a specific sample range.
- SET ABSOLUTE/DYNAMIC SCALE. Set display mode to absolute or dynamic mode.
- SET SCALE ON/OFF. Remove or show scale information.
- SET DEFAULTS. Restore to the default display.
- CLEAR LOG DATA. Clear the log and start a new sampling.

3.3.13 Self-test

The M-Panel graphical has a built in self-test program. It can be invoked by holding down three buttons down simultaneously while applying the supply voltage. The self-test opening window is shown in Figure 9.



Figure 9. Self-test opening window

The test sequence is as follows:

- Visual interface test.
Three pixel patterns will be shown successively on the display. Upon each new pattern appearing on the display, a new LED is lit, and a short beep will be heard.

If the LCD contrast is poor, it can be adjusted with a small Philips screwdriver from the back of the M-Panel. See Figure 10 below.

LCD contrast adjustment

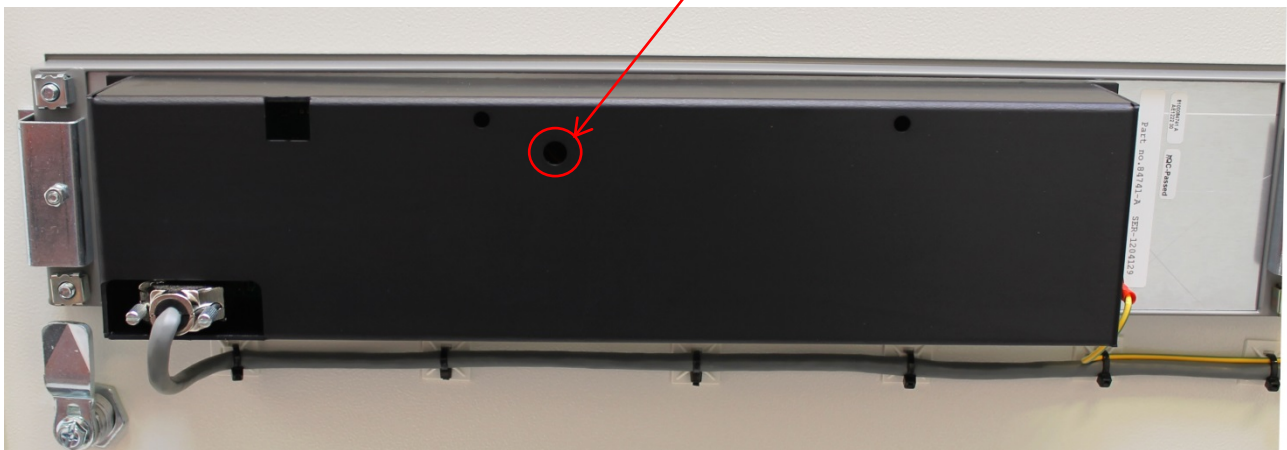

Figure 10. LCD contrast adjustment

- Serial line and M-Panel buttons.
This test requires some user assistance: When the test software prompts you to connect the RX and TX line, just continue; the software is designed to have the TX looped back to the RX on the serial line (as the software is also used during factory test of the module). When the module is installed in a Magnet Power Supply (i.e. connected to a control module), this, however, is not the case.
Consequently, this will result in error messages, when testing the keys, as shown in the "receive window" in Figure 11 below. These messages should be accepted as good working conditions, considering that the key pressed was acknowledged. The test software transmitted the code, but the control module was not able to recognize it, thus answering with error messages.

Figure 11 shows the end test window after some keys have been pressed. The text in the "receive window" indicates that the M-Panel is connected to a Control module; else the text will be the same on both sides.

| Titel line | Key pressed & tested | Key order: |
|--------------|----------------------|---|
| | | {RES, MENU, =, <, >, ?, ³ , OFF; ON} |
| M-PANEL TEST | TX | RX |
| PCB rev 1 | &TEST UP | ?Δ 4 |
| X1000000XX | &TEST LEFT | ?Δ 4 |
| | &TEST RIGHT | ?Δ 4 |
| RAM ok | &TEST RET | ?Δ 4 |
| EEPROM ok | &TEST MENU | ?Δ 4 |
| Press RES | | |

Internal test & to do line
Transmit window
Recieve window

Figure 11. Self-test window

3.4 Operating by RS 232-C, RS422 or RS 485 I/O

The Control-Module uses standard serial interfaces compatible with most computers and terminals.

Two data communication lines are available:

- A REMOTE LINE, with either RS 232C, RS 422 or RS 485 communication.
- A LOCAL LINE, with either RS 232C, RS 422 or RS 485 communication.

The two channels are galvanically isolated from all other internal voltages through opto-couplers but are supplied from the same voltage source.

3.4.1 Setting up the MPS

The setup of the MPS is done through software commands. Please refer to the 'ESC' commands in the programmers guide. If for some reason you are unable to communicate with the MPS through software commands (e.g. after a reset to factory defaults), a technical note regarding MPS setup through hardware is located on the CD-ROM.

3.4.2 Resetting to factory defaults

Reverting all setups to factory defaults can be accomplished as follows:

1. Short-circuit ST60 (below SW2). Simultaneously press and hold S2. See Figure 12, page 34.
2. All green parameter LED's will start flashing. After the fifth flash, the default parameters are restored.

Note: All parameters will be reverted to factory defaults, including the ON pulse width and any selected addresses. Reverting the ON pulse width may cause the Magnet Power Supply to be unable to be turned ON.

Table 7 below shows the settings after a reset to factory defaults.

Table 7. Settings after a reset to factory defaults

| Setting | Default parameters | | |
|-------------------------------|--------------------|---|---|
| REM UART Set up | Local line: | 9600 Baud, no parity, 8 bits, 2 stop bits | |
| | Remote line: | 9600 Baud, no parity, 8 bits, 1 stop bit | |
| Address line set up | Local line: | Addr 0 | |
| | Remote line: | Addr 0 | |
| Line function protocol set up | Local line: | RS 485 Communication: | Disabled |
| | | Line turnaround time: | Bit 2: 0, Bit 3: 1 Delay = time to transmit 2 dummy characters |
| | | OK answer mode: | Disabled |
| | | BOOT character: | "FF" / "R" |
| | | XON/XOFF Protocol: | Disabled |
| | Remote line: | RS 485 Communication: | Disabled |
| | | Line turnaround time: | Bit 2: 0, Bit 3: 1 Delay = time to transmit 2 dummy characters |
| | | OK answer mode: | Disabled |
| | | BOOT character: | "FF" / "R" |
| | | XON/XOFF Protocol: | Disabled |
| Cold boot set up | | Remote addressing: | Disabled |
| | | Local addressing: | Disabled |
| | | Default line in: | Local |
| | | Remote auto answer: | Disabled |
| | | Error response: | "?"-BELL only |
| | | Wake up output current: | 0% |
| | | | |

| Setting | Default parameters | | |
|-----------------------------|--------------------|--------------------------|---------------------------------|
| Aux. set up 1 | | DAC 16 & 17 (bit 1 & 2): | Transparent |
| | | Interlock clear: | OFF & CLEAR resets interlocks |
| | | "WA" zeroes: | WA command uses trailing zeroes |
| | | Uni-/bipolar DAC: | Unipolar |
| ON pulse time set up | | ON time: | 0.5 seconds |
| Aux. Output-1 ON pulse time | | Static level operation | |
| Polarity delay time | | No polarity delay | |
| Aux. Set up 2 | | ADC multiplication: | +1 |
| | | Polarity status signals: | Normal (not inversed) |
| | | CAMAC ON/OFF control: | CAMAC |
| | | Auto slew rate shape: | Cosine |

3.4.3 Data communication

Connection for the host is located on the Control Board behind the front door. The cable can get access to the board through the front-hole in the bottom of the cabinet.

The pin numbers on the D-SUB Female 25 - pin connector determines the communication type (i.e. RS 232C, RS 422 or RS 485).

The direction used in the tables below is:

Rx: Signals received by the Control Module from its host.

Tx: Signals transmitted by the Control Module to its host.

Table 8. RS 232C Pin out DB25

| Pin No. | Signal |
|---------|--------|
| 2 | Tx |
| 3 | Rx |
| 7 | GND |

Table 9. RS 422 Pin out DB25

| Pin No. | Signal |
|---------|---------|
| 7 | GND |
| 9 | Tx High |
| 10 | Tx Low |
| 11 | Rx High |
| 12 | Rx Low |

Table 10. RS 485 Pin out DB25

| Pin No. | Signal |
|---------|--------------|
| 7 | GND |
| 9 | Tx / Rx High |
| 10 | Tx / Rx Low |

Note:

The selection between RS 232C, RS 422 and RS 485 is done by jumpers on the control board.

See Figure 13 below for reference.

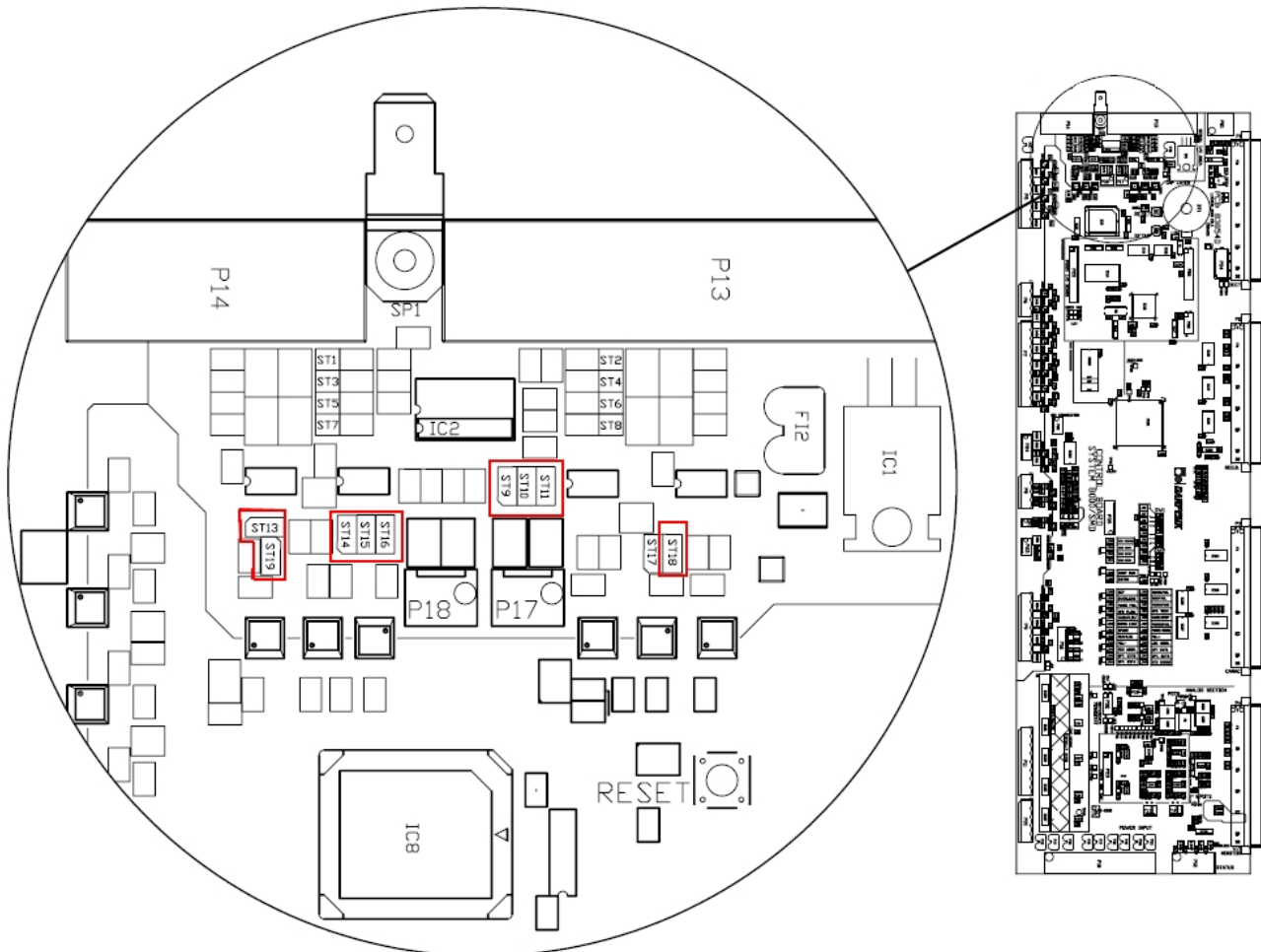

Figure 13. Jumper locations for serial communication protocol selection

Table 11. Local line, jumper settings for data communication

| Communication protocol | Jumpers S/C | Jumpers O/C |
|------------------------|-------------|------------------|
| RS232C | ST16 | ST14, ST15 |
| RS422 | ST15 | ST14, ST16 |
| RS485 | ST13, ST14 | ST15, ST16, ST19 |

Table 12. Remote line, jumper settings for data communication

| Communication protocol | Jumpers S/C | Jumpers O/C |
|------------------------|-------------|-----------------|
| RS232C | ST9 | ST10, ST11 |
| RS422 | ST10 | ST9, ST11 |
| RS485 | ST11, ST18 | ST9, ST10, ST17 |

3.4.3.1 Termination using RS 422 or RS 485

There is no termination resistor mounted inside the control module. An external termination resistor of 100 Ohm must therefore be added at the end of the communication cable. This is applicable for both the local and the remote line.

Note: This resistor can be placed inside the last DB 25 plug for the remote line and the DB9 plug for the Local line.

When using the RS 485 or the RS 422 line in the multi drop configuration, it is very important during an address transfer to leave the lines at the "SPACE" state when tri stated. That is when the line is not driven by any transmitters at all. The "SPACE" state can be utilized by adding 1K Ohm resistors to +5V(non-inverting) and GND (inverting) on both the transmit and the receive lines.

Note: None of the serial lines have control signals (handshake signals). Use the XON/XOFF protocol if necessary.

3.4.4 Programming

The Magnet Power Supply (MPS) communication protocol is built upon plain ASCII characters where each command or reply is delimited by a "Carriage Return" <CR> character. However, replies have a "Line Feed" <LF> character added before the <CR> for a friendlier display when using a terminal. <LF> characters on commands will be ignored.

Note:

- The protocol allows full control of the MPS from a simple terminal. In case of a service/debug situation, a terminal can be used to tap the communication transfer by parallel connection.
- When debugging, the "ERRT" command enables error messages to be given as readable text.

Several commands may be transmitted in a chain, but each single command must be trailed individually with the delimiter character <CR>. The MPS is able to execute up to 200 commands a second depending of the complexity of each command.

Ps. Issuing short commands faster than the time to transmit the answer e.g. "S1" will overload the internal transmit buffer regardless of the selected baud rate.

All commands can be divided into three sections:

- a) Directive commands. E.g. the "N" command that turns the MPS ON
- b) Status commands. E.g. the "S1" that returns the MPS status
- c) Set up commands. E.g. the "ESC"<PPULS 5 that sets the ON pulse to 0.5 seconds.

Status commands always deliver a reply, whereas directive and setup commands only respond with an error message, if the command couldn't be understood, or if the given parameters are incorrect.

From SW version SCS110 it is possible to set the MPS to always generate an answer (see 'esc'LINE setup for SW version SCS110). This feature is very useful when using the RS485 protocol.

Note: When using the "Always Answer" mode ('OK' response from SW version SCS110) a retransmission of the last given command can be performed if no answer or an error message is received. The System 8500 respond time is approx. 5ms after receiving the last bit of the termination character.

Answer scheme if set to "Always Answer" mode.

- a) Directive commands Answer:
- No answer
 - ERROR message
 - OK if set to always answer mode
- b) Status commands Answer:
- Data
 - ERROR message
- c) Set up commands Answer:
- No answer
 - ERROR message
 - OK if set to always answer mode

Below is an example written in BASIC on how to turn ON the power supply and read the status without and with acceptance answer:

Turning the power supply ON and reading/evaluating the status with always answer **disabled**:

```

LPRINT "N"+CHR$(13)           :REM Turns the power supply on
LPRINT "S1"                   :REM Issues the status command
LINPUT S1$                    :REM Read the MPS reply
IF LEFT$(S1$,1) = CHR$(?)    :REM Is it an error message reply?
  GOTO ERROR_HANDLING        :REM Yes then go to error module
ENDIF
J=1
DO                             :REM evaluate status reply
  IF MID$(S1$,J,1)="!"
    GOSUB STATUS(J)_ACTIVE   :REM set this status bit active
  ELSE
    GOSUB STATUS(J)_ACTIVE   :REM set this status bit inactive
  ENDIF
  J=J+1
UNTIL J=24

```

Turning the power supply ON with always answer **enabled**:

```

J=0                             :ERROR$=""
DO
  J=J+1                         :REM Counter for maximum attempts
  LPRINT "N"+CHR$(13)           :REM Turns the power supply on
  LINPUT RE$                    :REM Read the MPS reply with 0.1 Sec. time out
  IF LEFT$(RE$,1) = CHR$(?)    :REM Is it an error reply?
    ERROR$=RE$                 :REM Mark the error code
  ELSEIF RE$="OK"               :REM Is it a good reply
    BRAKE                      :REM then exit DO loop
  ELSEIF J=6                   :REM Try only six times
    IF LEFT$(ERROR$,1) = CHR$(?):REM Was it error reply?
      GOTO ERROR_HANDLING      :REM Yes then go to error module
    ELSEIF
      GOTO NO_COMMUNICATION    :REM Yes then go to "No answer" error module
    ENDIF
  ENDIF
UNTIL -1                       :REM loop endless

```

Note: An ERROR message includes a "?BELL". (Bell = ASCII 7.)

3.4.5 Software Profile Programming (Optional)

The RAMP PROFILE software is an option that can be ordered with the Magnet Power Supply (MPS) or be added to a present system. No additional hardware is needed.

With the ramp profile SW, it is possible to download and run a pre-defined ramp sequence that the output current must follow. The ramp sequence can be programmed in three quite different methods.

- a) Arbitrary point method;
- b) Equal timeslot method;
- c) Auto Slew Rate Ramp Profile method.

If the MPS is delivered with the software ramp profile option, then all three methods will be available, but only one method can be used at a time. The examples below are shown for a unipolar MPS. For bipolar supplies, the output current may also be set negative.

3.4.5.1 Arbitrary point ramp profile method

With the "Arbitrary point method", it is possible to download up to fifteen independent points each generating a ramp line (through interpolation). This profile must be stored in one of the 15 available stacks.

Each ramp point consist of a stack number, a starting point (current set value, normally the previous end point), an end point (current set value) and a time value for reaching the given end point.

E.g. Command: WSA' sp' stack, start, stop, time 'cr'

To use the arbitrary point method at least the following steps must be performed:

- Clear the stack "CSS [parameter]",
- Program the stack "WSA [parameter]",
- Set the speed "SPEED [parameter]",
- Set the attenuator "MULT [parameter]",
- Start the stack "TS [parameter]",
- Read the status of the running stack "S2".

Please refer to the programmer's guide, section explaining "Ramp Profile Commands" for full instructions.

The figure shows an example of one ramp profile stack. (Ps. not all 15 points need to be programmed - empty entries will be ignored.)

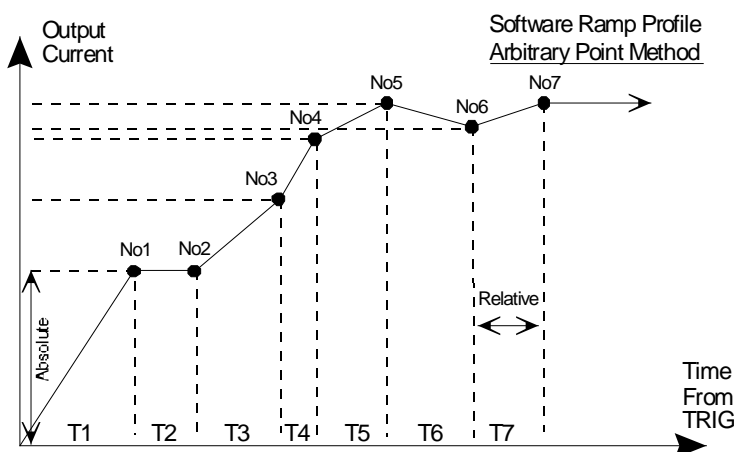

Figure 14. Arbitrary Point Ramp profile

After the start (Trig) command, the SW will update the output current every 1.25ms in both the FAST and SLOW mode (Step Time). This enables it to calculate the stair case size (interpolating step size) according to the formulae below:

$$\frac{(Start - End) \times StepTime}{\Delta t} = Stepsize$$

Where "START" and "END" are the set values in ppm, The "Step Time" is 1.25ms, Δt in seconds and the "Step Size" will come out as ppm value.

In-between the 1.25ms step time a second HW interpolation counter will update the set value for every 78 μ s.

Starting the ramp is done with the trig command "TS (stack no.)".

If synchronization to an external event is required, it is possible to arm the ramp sequence first with the synchronization command "SYNC (stack no.), [trigger delay]". A hardware signal on the trigger input P33 pin 1&2 (10 to 24V) or a TS command will start the sequence. If a trig delay is entered, the sequence will start after the delay time has elapsed.

If more power supplies have to be synchronized, one of the supplies has to be appointed as master. Connecting the master trig output P33 pin 3&4 to the other supplies trig input will start the other supplies when the master is triggered. A maximum skew of 5 μ s between the supplies may be expected. (An external 15V auxiliary supply is needed, as the trig output is an open collector and the trig input is an opto-coupler input.)

3.4.5.2 Equal time slot ramp profile method

With the "Equal time slot method" it is possible to download up to 1000 current set values and a single time slot value, that will be used for all set values. Only one stack is available. This profile method is especially useful for faster and more accurate curves fitting profiles e.g. as an function generator.

To use the Equal time slot method at least the following steps must be performed:

- Clear and set the stack "RAMPSET [parameter]",
- Program the stack "R [parameter]",
- Start the stack "RAMP [parameter]",
- Read the status of the running stack "RAMP".

PS. A difference in the value parameter setting compared to the "Arbitrary point method" is, that all values must be given as a floating point number scaled to "1.000000". That is; 1.25ms must be entered as 0.00125 and 19.54% output current as 0.1954.

Please refer to the programmer's guide, section explaining "Ramp Profile Commands" for full instructions.

The figure below shows an example of one ramp profile stack. (Ps. not all 1000 points need to be programmed empty entries will be ignored.)

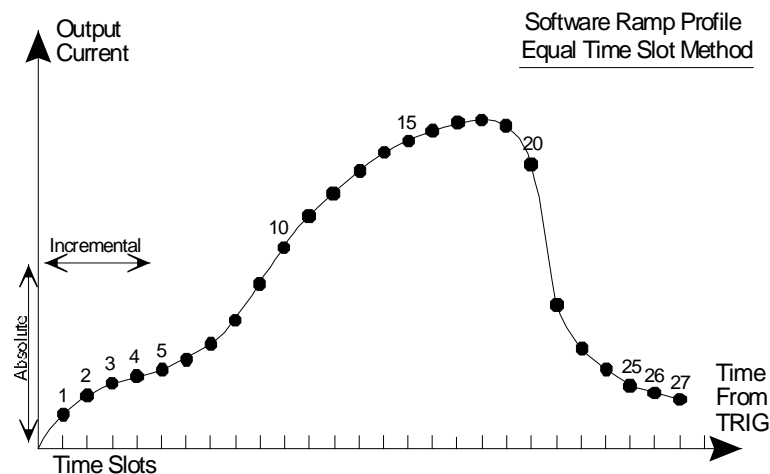

Figure 15. Ramp profile method.

The time slot must be given as a multiple of 1.25ms. Between 1.25ms to 1 second. Any value in between will automatically be rounded according to the following formula:

$$\{TimeSlot\} = \text{frac}\left(\frac{\{time\}}{0.00125}\right) \times 0.00125$$

After the start command, the SW will update the output current every 1.25ms. by means of interpolation regardless of the programmed time slot value:

In-between the 1.25ms step time a second HW interpolation counter will update the set value for every 70µs.

The ramp can be setup to run as a single shot "RAMP R", auto iteratively (auto loop) "RAMP RL" or HW triggered auto armed "RAMP TW". For full documentation on controlling the "Equal time slot method" please refer to the programmer's guide, section explaining "Ramp Profile Commands".

If synchronization to an external event is required, it is possible to arm the ramp sequence first with the synchronization command "RAMP T". A hardware signal on the trigger input P33 pin 1&2 (10 to 24V) or a "RAMP R" command will start the sequence.

If more power supplies have to be synchronized, one of the supplies has to be appointed as master. Connecting the master trig output P33 pin 3&4 to the other supplies trig input will start the other supplies when the master is triggered. A maximum skew of 5µs between the supplies may be expected. (an external 15V auxiliary supply is needed, as the trig output is an open collector and the trig input is an opto coupler input.)

3.4.5.3 Auto Slew Rate Ramp Profile method

With the "Auto Slew Rate Ramp Profile Method" an automatic ramp profile will be generated and executed when issuing a new current set point. In other words, this feature acts like a software driven slew rate controller.

Two shapes can be preselected: a cosine and a square shape. Which shape is selected, is given by the Aux2 setting bit 4: 0=Cosine & 1=Square

Example: If the MPS is at 10% output current, the slew rate is set to 1 second ('esc'<slopetime 1,1) and a set command "da 0,600000" is given the MPS will start at 10% and run to 60% within ½ a second with the selected shape.

The positive and negative slew rate value can be set individually. Please refer to the programmer's guide, section describing the "'esc'<slopetime 'val1','val2'" for further information.

The two ramp profile shapes has both its benefit and draw backs. The cosines shape is smooth all the way but has a higher di/dt in the middle and results in a sinus output voltage shape on an inductive load whereas the square shape results in a trapezoidal output voltage. The ramp profile consists of 80 points with HW interpolated points in-between. Each of the 80 points has a distance of 1.25ms. In-between profiles with distances shorter than 100ms (80*1.25ms) are achieved by omitting points. E.g. a ramp time of 10ms will only consist of 8 points thereby resulting in a more coarse profile.

The figures below shows the shape of the two ramp profiles.

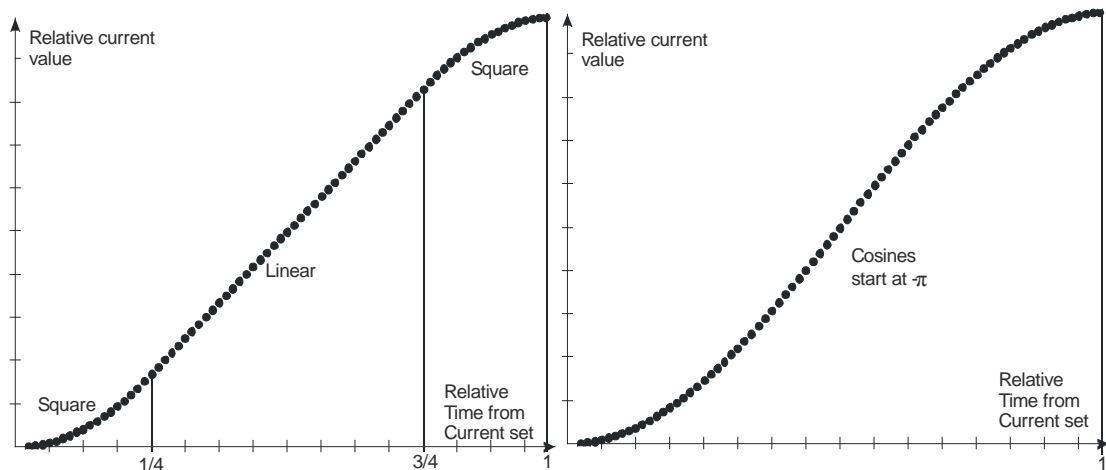

Figure 16. Ramp profiles when using auto slew rate

The time slot must be given as a multiple of 1.25ms. Between 1.25ms to 1 second. Any value in-between will automatically be rounded off according to formulae:

$$\{TimeSlot\} = \text{frac}\left(\frac{\{time\}}{0.00125}\right) \times 0.00125$$

The ramp profile can be stopped either with a "STOP" command or when the MPS is turned OFF. The state of the ramp profile can be read through the "RR" command.

3.4.5.4 SW limits

The limits of the "Arbitrary point method" ramp profile SW are:

- The set value must be given in ppm units
- The time between two points can be between 0.2 to 65535 seconds.
- Maximum numbers of stacks: = 15
- Maximum number of lines in a stack: = 15

The limits of the "Equal time slot method" ramp profile SW are:

- The set value must be given in a floating point representation normalized to 1.000000.
- The time slot may be between 0.0125 to 1 second given in a floating point representation normalized to 1.0000.
- Maximum numbers of stacks = 1
- Maximum number of time slots in a stack = 1000

The limits of the "Auto Slew Rate method" ramp profile SW are:

- Maximum positive slew rate time = 10 sec,
- Maximum negative slew rate time = 10 sec,
- Minimum positive slew rate time = 5 ms,
- Minimum negative slew rate time = 5 ms,
- Number of points = 80 with a minimum interval of 1.25ms

3.4.6 Two level value set

The two-level value set function enables the MPS to quickly switch between two arbitrary given set points. For bipolar power supplies e.g. it could be between any positive and negative value. For unipolar power supplies it could be between any positive value and zero.

The two-level value function, which is always enabled, is partially implemented in HW (inside the FPGA) and SW. If this function is not used, set register 0 will be selected by default, making the system both HW and SW compatible with previous versions.

The two levels can either be selected through SW from an added parameter in the 'da 0' command or through HW using the 'SYNC' line. If the 'SYNC' line is used for the two level select, it must first be enabled by setting 'AUX2 bit 5' to "1" thereby deselecting its use for ramp synchronization purposes.

The two-level function is shown in the simplified block schematic below:

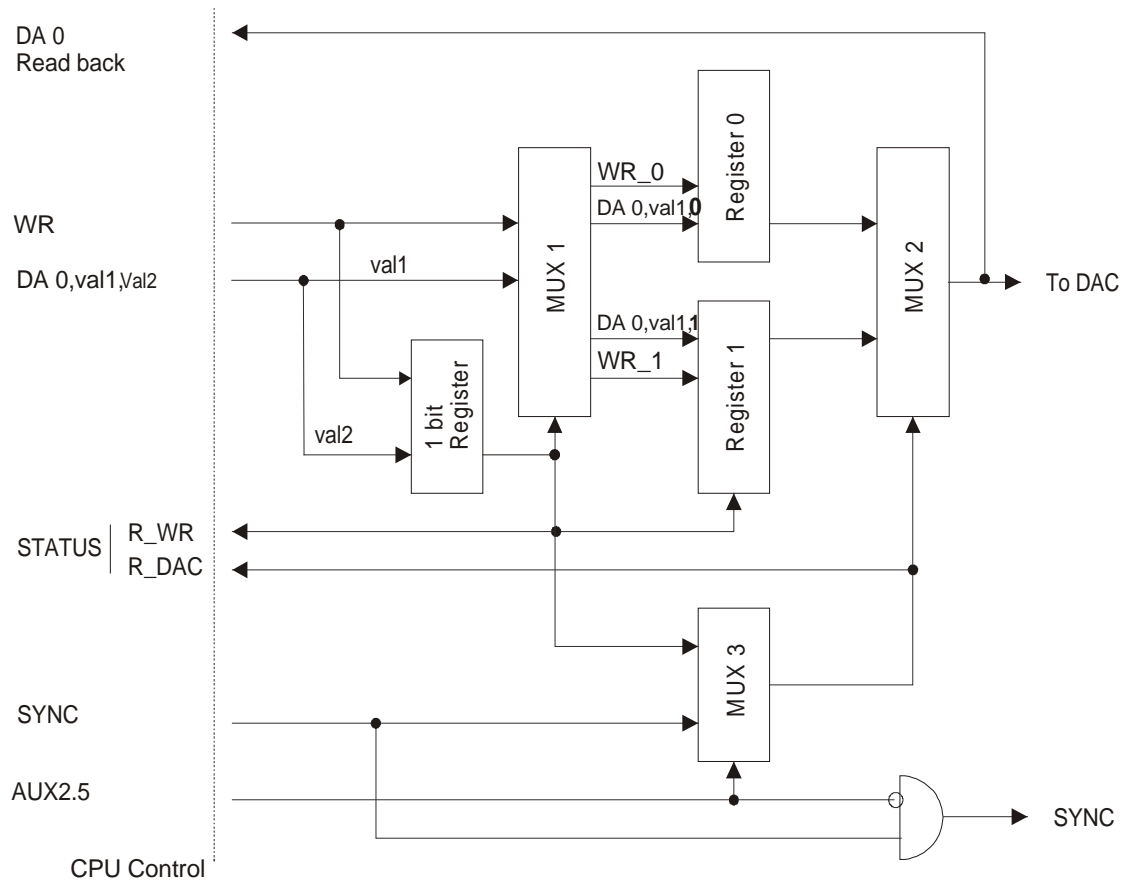

Figure 17. Simplified schematic of two-level value set.

3.4.6.1 Using the two-level function

Selecting which register to set:

Writing to register 0 with the 'da 0, val1, val2' command requires 'val2' to be "0", and writing to register 1 'val2' must be "1". In other words 'MUX 1' routes 'val1' to either register 0 or 1 according to its information. Not specifying 'val2' will update the last selected register. Changing the register without altering the set value can be done by omitting the 'val1' information. E.g. changing to register 1 is done with the command 'da 0,,1'.

Note: Changing the output current with the M-Panel will be performed through the last selected register.

Selecting which register to be used for the DAC:

'MUX 2' routes one of the two set registers to the DAC, which in turn sets the output current of the MPS. 'MUX 2' is controlled from the AUX2 bit 5 setup setting. See the programmer's guide on how to set the AUX2 bits. If AUX2 bit 5 is zero (SW control) will the used register to the DAC follow the 'val2' information issued by the 'da 0, val1, val2' command. That is, selecting register 0 for writing, will also select register 0 be connected to the DAC. If AUX2 bit 5 is one (HW control) will the used register to the DAC follow the HW SYNC signal.

Note: Using the SYNC line for the two-level function will automatically disable its use for the ramp profile synchronization.

Reading which register is selected for writing and which to be used for the DAC:

The two-level HW circuit delivers the MUX1 & MUX2 control lines back to be used as status indication on how the registers are routed. This status can be read with the command 'da 0,r', which delivers following answer: 0,xxxxxx,yy where:

xxxxxx is the given DAC value

yy First **y** is the selected register for writing (MUX 1 position)

Second **y** is the selected register to DAC (MUX 2 position)

3.5 Instructions for initial Remote line set up RS232C/RS422/RS485

For instructions on the settings below please refer to chapter 3.4 and the programmer's guide.

1. Set the REMOTE LINE HW protocol to the desired mode RS232C, RS422 or RS485 by inserting strap ST9, ST10 or ST11 respectively. See Figure 13, page 36 for the strap locations.
 - 1.1. If RS485 is selected the "LINE FUNCTION PROTOCOL SETUP" has to be set accordingly.
2. Select BAUD RATE and PARITY for the REMOTE LINE.
3. Select the command to RESET the Interlocks. "OFF" or "RS".
4. Select the CONTROL MODE during power-up to be LOCAL or REMOTE
5. Select ANSWER mode (ASW) or NO ANSWER mode (NASW)
 - 5.1. If the Magnet Power Supply is to be used in a multiplexed system, set the ADDRESS mode to "enable".

3.6 Operating by IEEE 488 (Optional)

The IEEE interface uses the NI Measurement & Automation Explorer, which can be downloaded from National Instruments' website. For troubleshooting on interfacing or PC drivers, please consult the NI website.

1. Turn the MPS OFF.
2. Connect the IEEE interface to your PC. The interface is located on the electronics plate behind the front door. (See chapter 2.5 – Electrical Installation for reference.)
3. Turn the MPS ON and select REMOTE CONTROL from the CMD menu on the M-Panel.
4. Open the NI-MAX (Measurement & Automation Explorer).
5. Click on "Devices and Interfaces", "GPIB0" and click "Properties".
6. Set the time out to at least 30 sec. and click "Scan for instruments".
7. The MPS will now pop up in the list.
8. Set up the communication line. Please refer to NI-MAX Help or the NI website.
9. Test the communication by sending a couple of Danfysik commands. (E.g. the "N", "F" and "S1" commands.)
10. The remote line will now be ready for use.

The default parameters set by Danfysik are:

| | |
|----------------------|--------------|
| Baud rate: | 9600 |
| Data bits: | 8 |
| Parity: | None |
| Stop bits: | 1 |
| Flow control: | None |
| Listen only: | OFF |
| GPIB Primary addr: | 1 |
| GPIB Secondary addr: | 0 (Disabled) |
| SRQ: | OFF |

3.7 Operating by Ethernet Interface (Optional)

The Magnet Power Supply can optionally be equipped with an Ethernet interface (Virtual COM-port), enabling remote controlling through LAN. The Ethernet interface is coupled to the remote line as shown below, thus replacing the RS232, RS422 and RS485 remote connection.

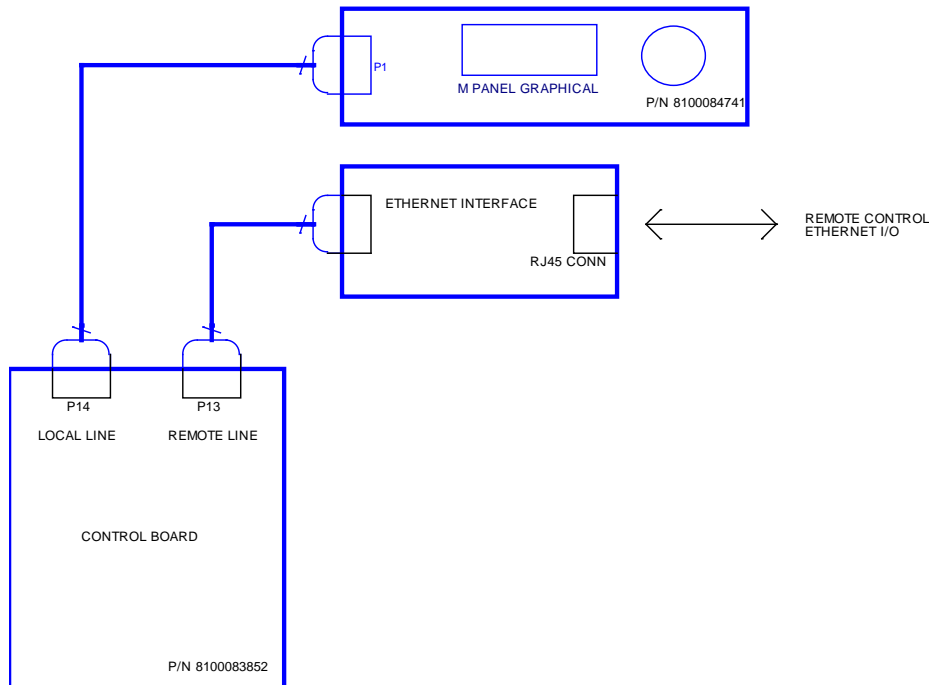

Figure 18. Remote control, Ethernet configuration

3.7.1 Setting up the Ethernet interface

The interface is a MOXA NPort 5150 device server, which creates a virtual COM-port through Ethernet. It needs a driver on the PC communicating with it (NPort Administrator included on a separate CDROM).

Via the NPort Administrator, the Ethernet interface can be set up and mapped to function as a particular COM-port on the PC.

The procedure for the setup is as follows:

1. Connect the Ethernet interface to LAN using a standard RJ45 Ethernet cable.
2. Install the NPort Administrator on the PC.
3. In "Configuration", press "Search". The device will now appear.
4. In "COM mapping", press "Add", check the devices to add, press "OK" and "Apply".
5. Note the COM-port that the device is mapped to (e.g. COM2)
6. The MPS is now accessible as a standard COM-port.

Default parameters set by Danfysik are:

Baud rate: 9600
 Parity: None
 Data bits: 8
 Stop bits: 1
 Flow control: None

3.8 Instructions for use of Analog Input (Optional)

The Analog Input option allows control of the MPS output via an external 0-10 VDC reference (i.e. 0 V equals 0 % output and 10 V equals 100 % output). The setup depends partly on which DAC Module is installed in the MPS. See the table below for DAC dependency. The procedure for use of the input is as follows:

1. Turn the MPS OFF.
2. Open the front door and select EXTERNAL reference on the INT/EXT switch.
3. Connect the external reference to the Analog Input BNC plug on the electronics plate.
4. Set the external reference to 0 VDC.
5. Turn the MPS ON and set the current (via the SET CURRENT menu on the M-Panel) as shown in the table below.

Table 13. DAC dependency

| If equipped with: | If equipped with: |
|--------------------------------|--------------------------|
| 82322 (18 bit DAC for MPS 854) | 91604 (I-loop DAC) |
| 84201 (16 bit DAC for MPS 855) | 92066 (MPS 853 DAC) |
| SET CURRENT: 0 ppm | SET CURRENT: 999999 ppm |

6. Check that the MPS responds adequately by adjusting the reference in steps of 1-2 Volts.
7. The Analog Input is now ready for use.

3.9 Instructions for use of Analog Fine Adjustment (Optional)

The Analog Fine Adjustment option is designed for NMR regulation applications, but may be applicable for other purposes as well. It allows the user to finely trim the output via an extra outlet on the DCCT head.

Turn the MPS OFF and connect your Fine Adjustment cable to the BNC plug on the electronics plate.

See chapter 2.5 - Electrical Installation

The output current change can be calculated via the formula below:

$$\left(\frac{\text{Fine adj. windings}}{\text{Current in DCCT head}} \times \frac{V}{R} \right) / 10^{-6} = \text{xxxx ppm}$$

Where: *Current in DCCT head* is calculated in Amps.

$\frac{V}{R}$ represents the current injected in the fine adj. plug.

4 Maintenance

4.1 Introduction

Servicing DANFYSIK Magnet Power Supplies is only allowed by trained and qualified personal.

**DANGER!**

Dangerous voltages capable of causing loss of life are present inside this Magnet Power Supply. Use extreme caution when accessing, handling, testing and adjusting.

**CAUTION!**

Only qualified personnel are allowed to maintain this equipment.

**DANGER! ELECTRIC SHOCK HAZARD!**

Disconnect power at switch board before attempting to work on the Magnet Power Supply. High voltages are present at the terminals and within the Magnet Power Supply for up to 10 minutes after disconnection of the electrical supply. Always ensure by using a suitable measuring device that no voltage is present prior to commencing work.

4.2 Preventive maintenance

In a normal operating environment, perform the following tasks at one year intervals:

- Clean all fan protection grilles.
- Vacuum clean the openings in the cabinet and all heat sinks mounted on printed circuit boards to ensure a normal flow of cooling air.
- Check that all screw connections to the primary and from the secondary of the transformer are tightened.
- Check that connections from the secondary of the transformer to the output terminals are tightened. (I.e. cable and bus bars carrying heavy current).
- Check that the water-flow switch works correct.
- Check that external interlocks are functioning (optional). E.g. Magnet over temp, Magnet flow switch, External Emergency Off.
- Check function of door interlock.

In dusty or dirty environments the above-mentioned points should be performed more often.

- Visually inspect the power supply for overheated components or other suspicious signs.

4.3 Adjustment and calibration

This power supply does not need any regular adjustment or calibration.

5 Spare parts, ordering of

The available spare parts may vary from supply to supply. As a rule of thumb circuit boards and major components can be ordered individually from Danfysik A/S.

All RMA-cases are handled via Danfysik's web based RMA-system. It can be accessed from the official Danfysik web page www.danfysik.com (via the Service & Test tab), where a RMA Quick Guide also can be downloaded. Alternatively the RMA-system can be accessed directly via www.dfservice.dk/rma/

Please include the following information in your request:

- Magnet Power Supply type (e.g. MPS 854).
- The serial number of the unit. See the data label on the front door.
- The module or component part no, you wish to order (e.g. 8100084741).

5.1 Handling ESD-sensitive components



CAUTION!

Observe precautions, when handling ESD-sensitive components. Electrostatic discharge can damage ESD-sensitive components such as the PCB's installed in this Magnet Power Supply.

Use a grounding armband or similar whenever working with these components.

Keep ESD-sensitive components in antistatic material during storage, transport or packing for shipment.

6 Troubleshooting

WARNING!

Troubleshooting may require investigation inside the Magnet Power Supply.

Only trained personnel is allowed to do debugging inside the power supply with Control and/or Main power applied to the power supply.

From the control panel

Verify if any interlocks are present

Inside the control crate

Verify if any LEDs are illuminated.

From remote control

Read the S1 command.

| Symptom | Check | Cause & action |
|--|--|---|
| NO RESPONSE FROM CONTROL PANEL - No lights in control panel | Check that control power is on. | Control power has been disconnected either at switch board or control power contactor in power supply |
| | Check Aux power supply in control crate is functioning. | AUX supply is defect. Replace Aux power supply |
| | Check cable connection between control board and control panel. | Interface cable is defect. Replace cable |
| | None of the above | Control board defect. Please contact Danfysik service desk at service@danfysik.dk for instructions for further debugging/replacement of defect board. |
| POWER SUPPLY CANNOT BE COMMANDED ON | 1. Are any interlocks present? - External interlocks or - Internal interlocks | For external interlocks the cause of the interlock must be found outside the power supply. This includes magnet over temperature, magnet water flow. Continue troubleshooting at magnet. |
| | Check connections to MAIN contactor. Verify that MAIN contactor receives 230V as control voltage when commanded ON | Defect MAIN contactor. |
| | None of the above | For internal interlocks see troubleshooting below. |
| | None of the above | Control board defect. Please contact Danfysik service desk at service@danfysik.dk for instructions for further debugging replacement of defect board. |
| NONE OR BAD REGULATION: | 1. Check ambient temperature, must be lower than 35°C | Room temperature too high. Temperature must be < 35°C for the power supply to operate correctly. Lower room temperature |

| Symptom | Check | Cause & action |
|--|---|--|
| | 2. Check the V_{CE} voltage, must be higher than 5 volt | V_{CE} is too low to provide proper regulation. This is caused by high load resistance or 3 phase input voltage is too low. For new configurations change the secondary voltage on main transformer upwards if taps are provided. |
| | 3. Check the temperature readout for the regulation board | Delta temperature more than +/- 0.5°C offset, it should approach - 0.2°C Failure on regulation board. |
| HIGH FREQUENCY OSCILLATION (more than 10KHz) | 1. Check all connections to Transistor interface board | Loose connections may cause oscillation at the output |
| | 2. Check the output capacitor and the CAP. filter board. | Loose connections may cause oscillation at the output |
| | 3. None of the above | Regulation board defect. Please contact Danfysik service desk at service@danfysik.dk for instructions for further debugging and replacement of defect board. |
| LOW FREQUENCY OSCILLATION (below 10KHz) | 1. Check all connections to Transistor interface board | Loose connections may cause oscillation at the output |
| | 2. Check connections to DCCT head. | Loose connections may cause oscillation at the output |
| | 3. Check that magnet time constant is lower than 3 sec. | If the magnet time constant is faster than 3 sec. the regulation is no longer able to operate stable. Please contact Danfysik service desk at service@danfysik.dk for instructions how to adapt to the magnet. |
| | 4. None of the above | Regulation board defect. Please contact Danfysik service desk at service@danfysik.dk for instructions for further debugging and replacement of defect board. |
| DC OVERCURRENT INTERLOCK | 1. Check green LED on Transducer board ("on" in normal operation) | LED must be "on" to indicate proper function |
| | 2. Check cable connections | Loose connection may cause DC overcurrent interlock |
| | 3. Check aux-power supply | |
| | 4. None of the above | Transducer board defect. Please contact Danfysik service desk at service@danfysik.dk for instructions for further debugging and replacement of defect board. |
| PHASE FAIL INTERLOCK | 1. Check phases at MAIN input. All 3 phases must be present. Voltage level must be equal within 10% | If all 3 phases are not present the power supply will switch of with Phase Fail Interlock. Error to be found at local switch board. Please see manual for switch board. |
| | 2. Check phase rotation, e.g. by swapping two AC main cables | If phase rotation is not correct the power supply will switch off with Phase Fail Interlock. |

| Symptom | Check | Cause & action |
|---|--|--|
| | 3. None of the above | Phase Relay defect. Please contact Danfysik service desk at service@danfysik.dk for instructions for further debugging and replacement of defect relay. |
| DC OVERLOAD INTERLOCK TRANSISTOR FAILURE, | 1. Check for illuminated red LED(s) on the transistor bank boards | Change the transistor(s) and fuse(s) |
| DC OVERLOAD INTERLOCK LOADLINE FAILURE, | 1. Check whether the load matches the power supply output data. | A Load line interlock after a "main power off" command with power out of the power supply is a normal operation |
| DC OVERLOAD INTERLOCK OVERCURRENT, | 1. Check green LED on DCCT board ("on" in normal operation) | Failure on Regulation board or Transducer board. Please contact Danfysik service desk at service@danfysik.dk for instructions for further debugging and replacement of defect parts. |
| | 2. Check connections to DCCT head. | |
| REGULATION FAILURE INTERLOCK | 3. None of the above | Failure on Regulation board. Please contact Danfysik service desk at service@danfysik.dk for instructions for further debugging and replacement of defect board. |
| | 1. Check aux-power supply | |
| MPS OVER TEMPERATURE INTERLOCK | 2. None of the above | Too hot cooling water causes the power supply to shut down with MPS over temperature interlock Readjust cooling water temperature. Too hot ambient air can cause the power supply to shut down with MPS over temperature interlock A power component causes the power supply to overheat. Please contact Danfysik service desk at service@danfysik.dk for instructions for further debugging and replacement of defect part. |
| | 1. Check cooling water temperature. Water inlet temperature must be less than 35°C | |
| | 2. Check ambient temperature. Ambient temperature must be less than 35°C | |
| THERMAL BREAKER INTERLOCK | 3. None of the above | If adjusted incorrect compared the power supply construction the thermal breaker may shutdown prematurely. Thermal Breaker defect. Please contact Danfysik service desk at service@danfysik.dk for instructions for further debugging and replacement of defect part. |
| | 1. Check adjustment of main input thermal breaker according to the specified and labelled requirements | |
| MAGNET FLOW INTERLOCK | 2. None of the above | an interlock in the magnet flow switch will cause a shutdown of the power supply an O/C of the cable from the magnet flow switch will cause the power supply to switch off. |
| | 1. Check cooling water flow for magnet. Flow must be as specified for the magnet | |
| | 2. Check connections from magnet flow switch to power supply | |

| Symptom | Check | Cause & action |
|--------------------------|--|---|
| MAGNET THERMAL INTERLOCK | 1. Check cooling water temperature for magnet. Water inlet temperature must be as specified for the magnet | an interlock in the magnet thermal switches will cause a shutdown of the power supply |
| | 2. Check connections from magnet thermal switches to power supply | an O/C of the cable from the magnet thermal switches will cause the power supply to switch off. |